

安特性曲线

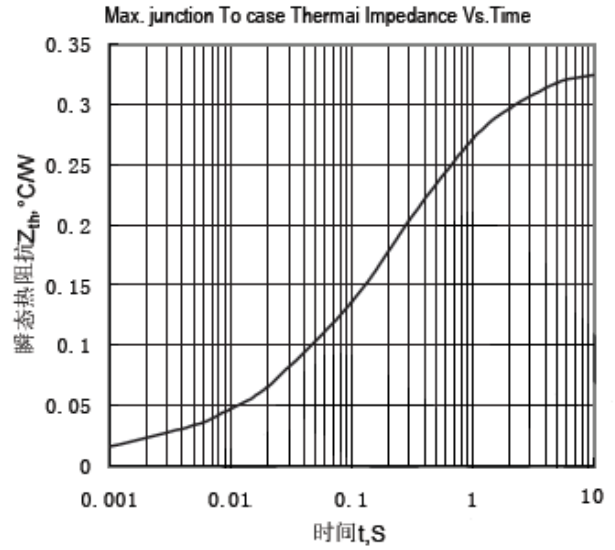

结至管壳瞬 热阻抗曲线

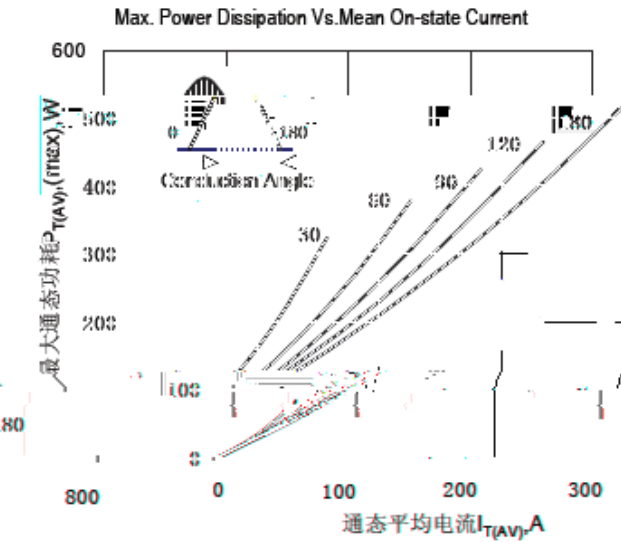

最大功耗与平均电流关系曲线

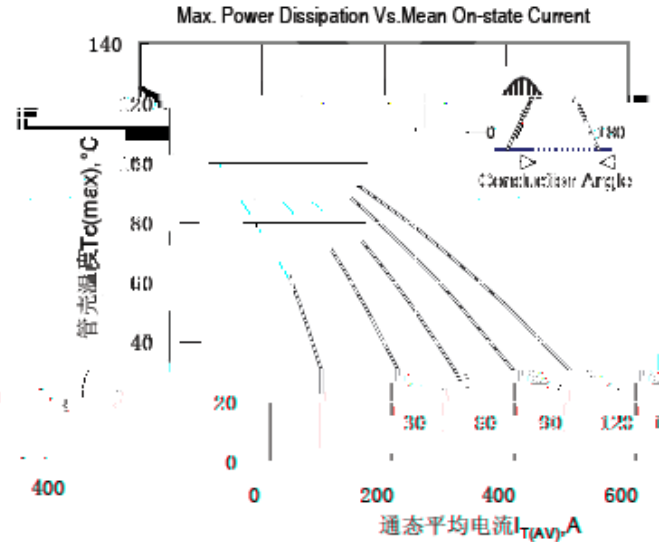

管壳温度与 平均电流关系曲线

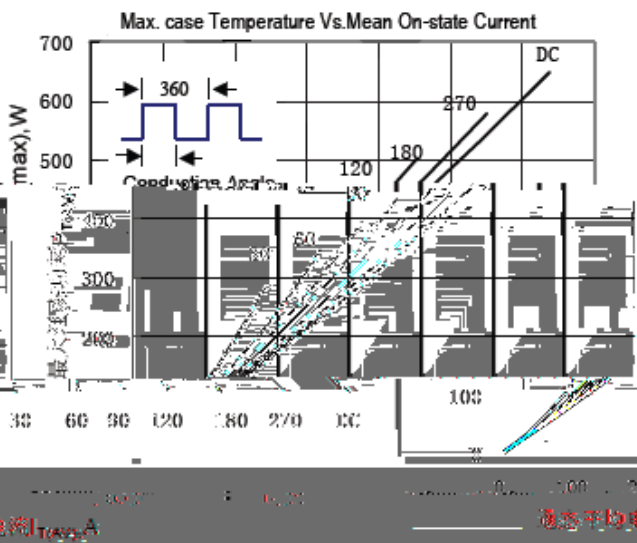

最大功耗与平均电流关系曲线

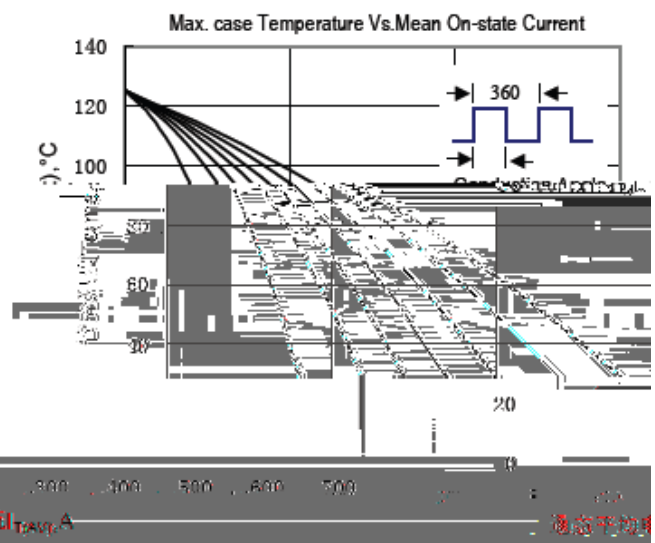

管壳温度与 平均电流关系曲线

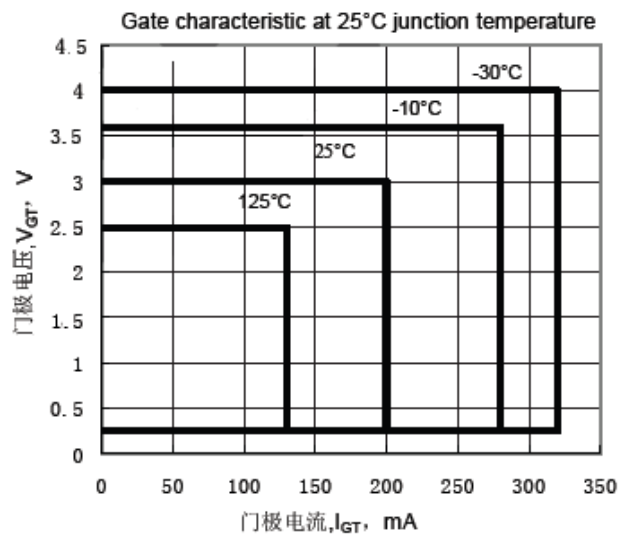
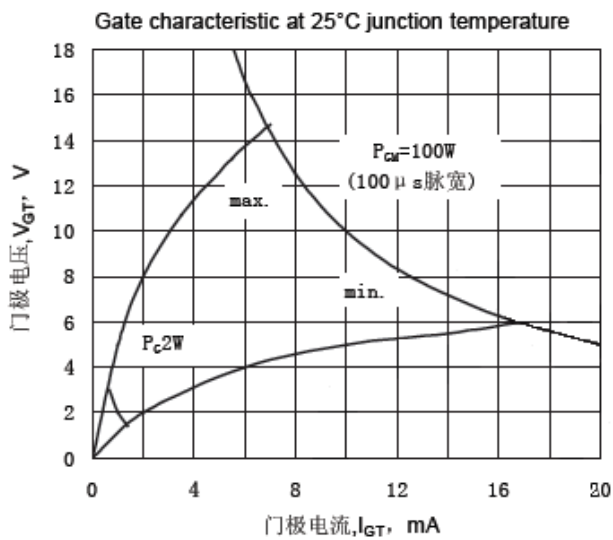
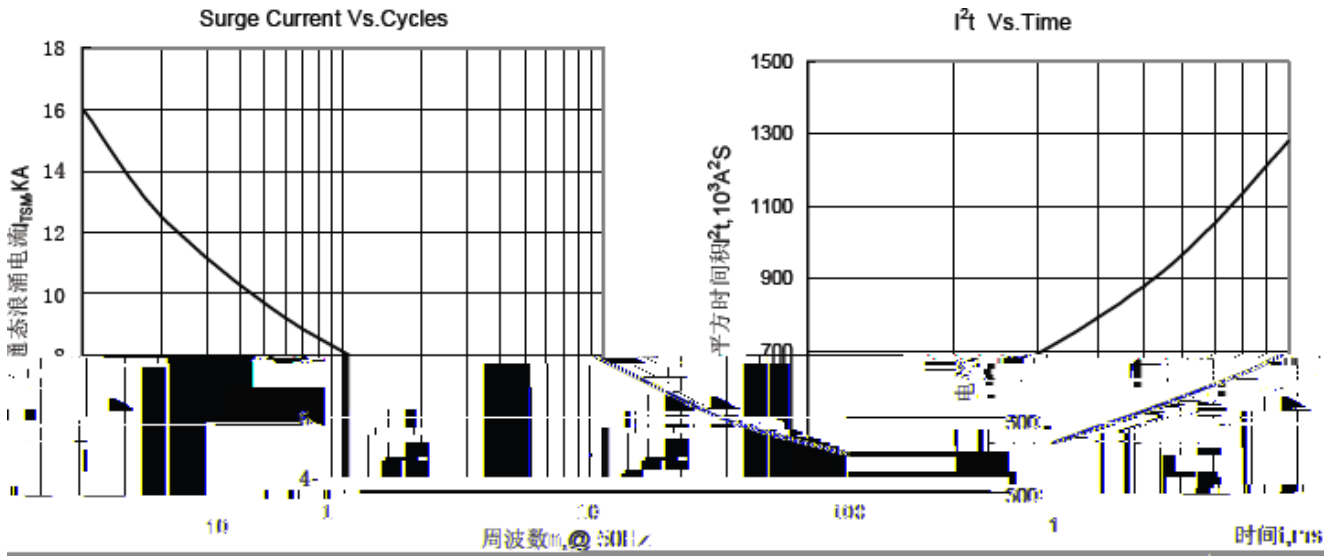

外形图:

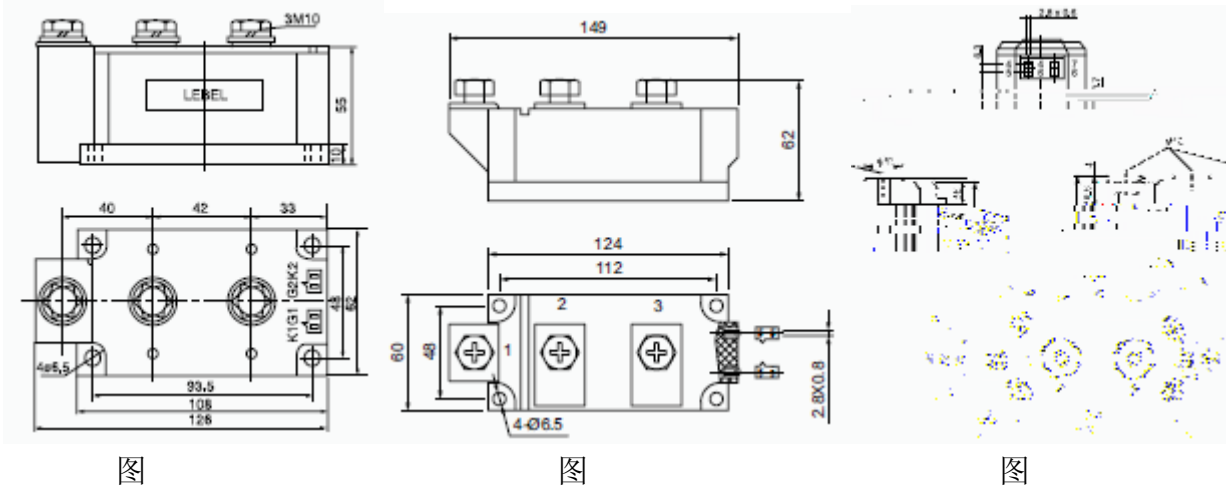

线路图:

MTC 250-1000A

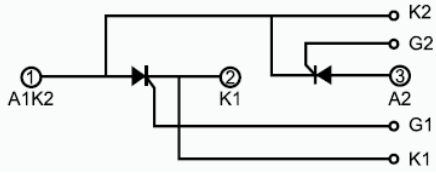

MTK

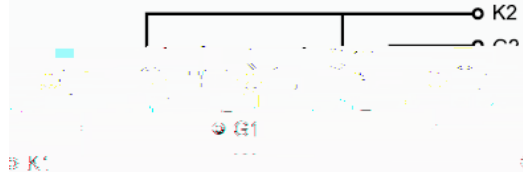

MTA

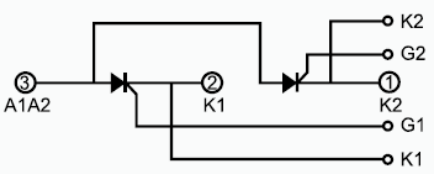

MTX

