

特点

2500V

350A

400A

典型应用

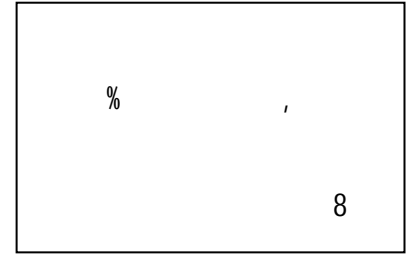

UPS

!					
"					
#\$%#					%&
#'%#			(%&
(≡	" ≡ &	
()		
(
* +,-					%
' /					
0				1	2,
					2,
3	储存 度			,1	
.	质量				4
! & 5'67	外形				

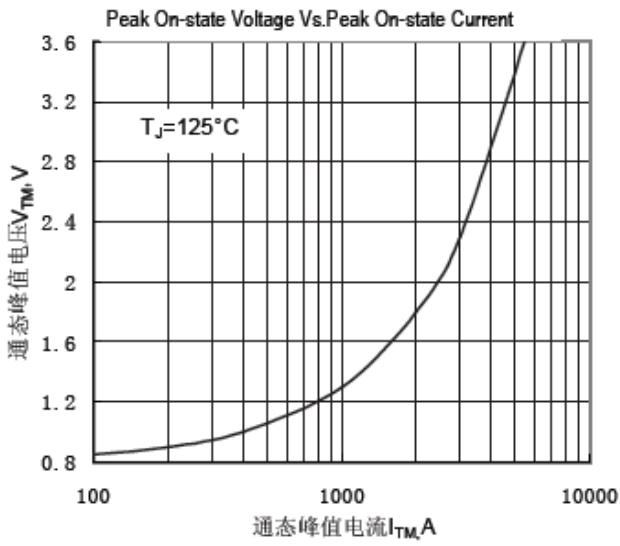

Fig.1 曲线

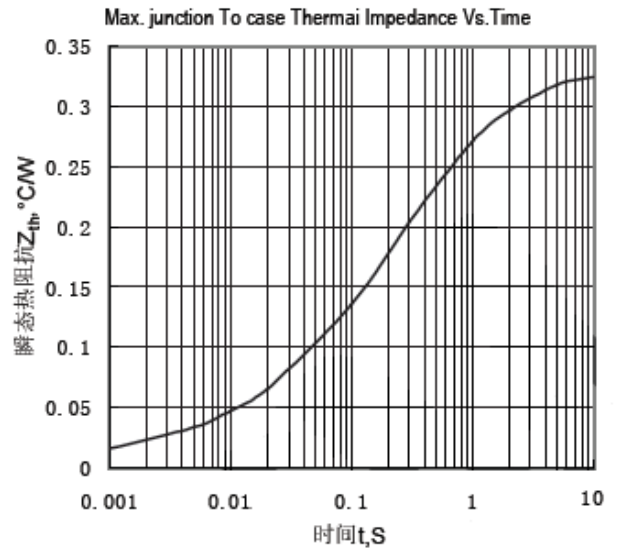

Fig.2 结至管壳瞬 热阻抗曲线

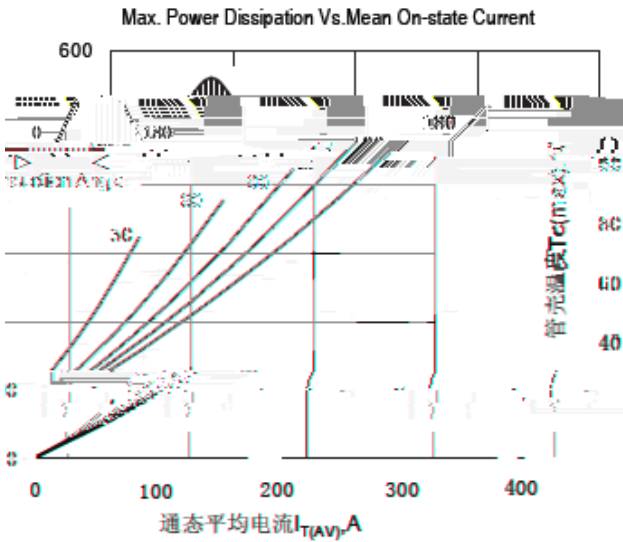

Fig.3 最大功耗与平均电流关系曲线

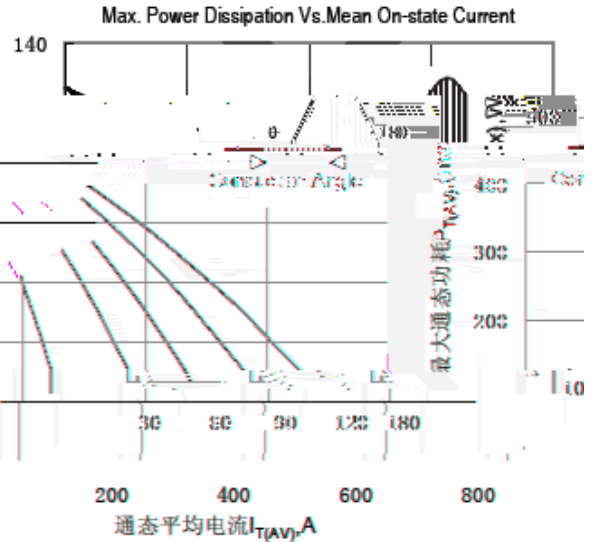

Fig.4 管壳温度与 平均电流关系曲线

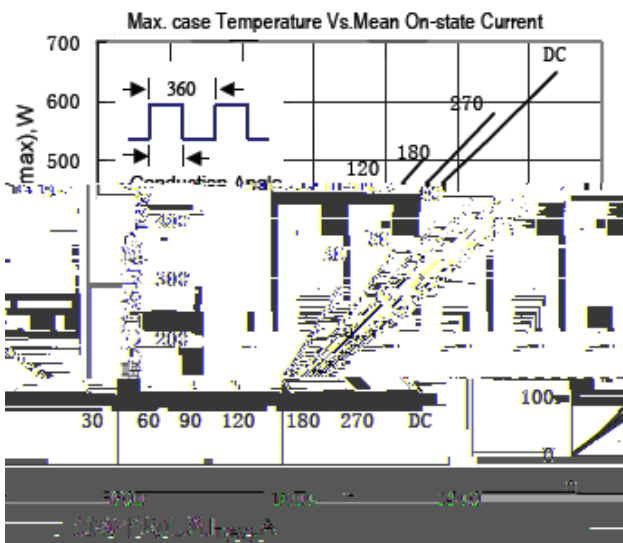

Fig.5 最大功耗与平均电流关系曲线

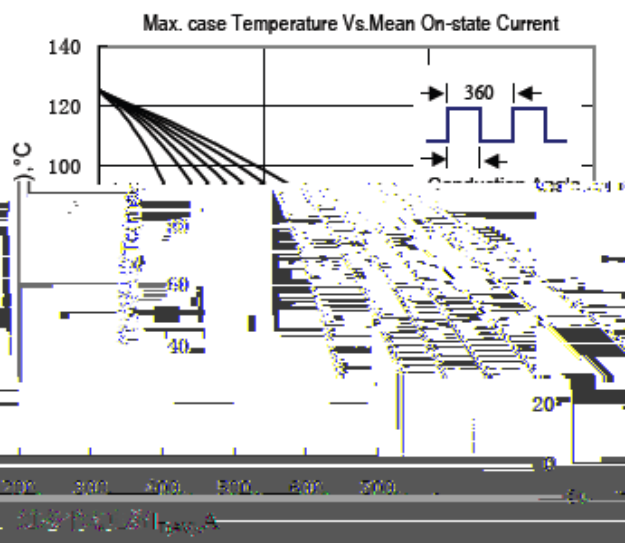

Fig.6 管壳温度与 平均电流关系曲线

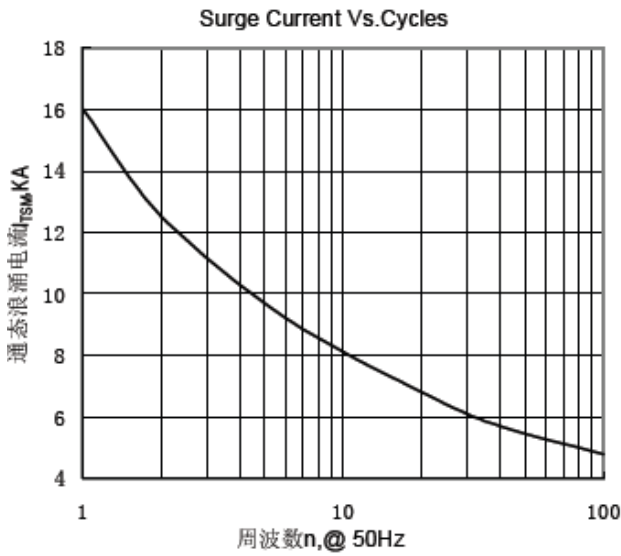

Fig.7 浪涌电流与周波数的关系曲线

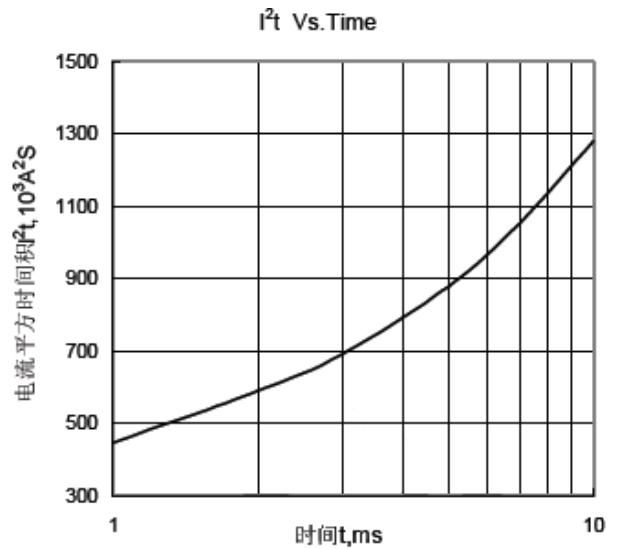

Fig.8 I^2t 曲线

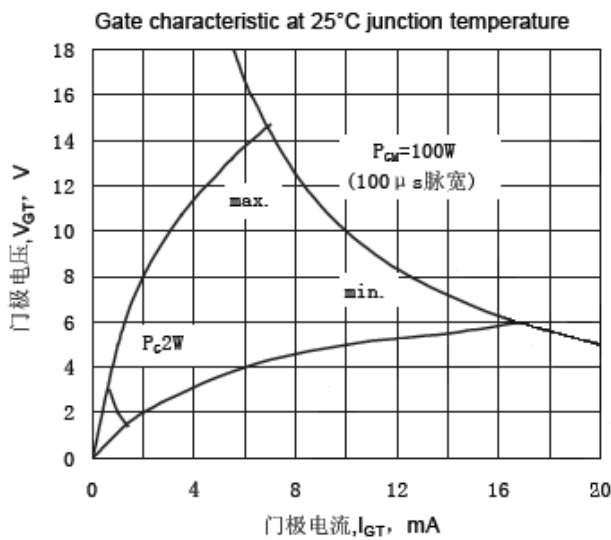

Fig.9 门极功率曲线

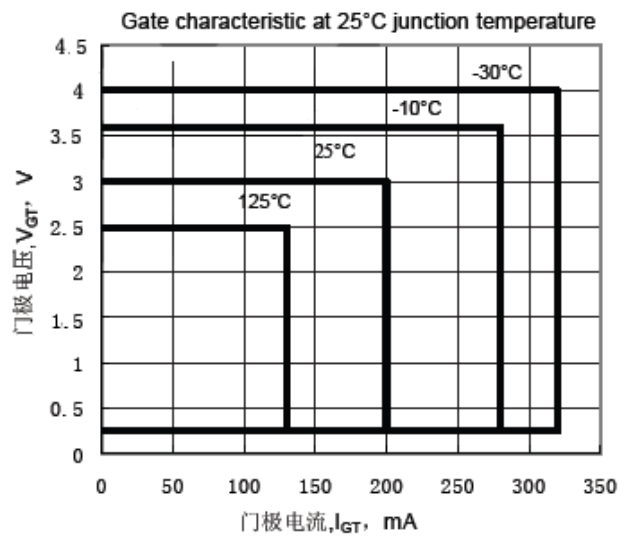
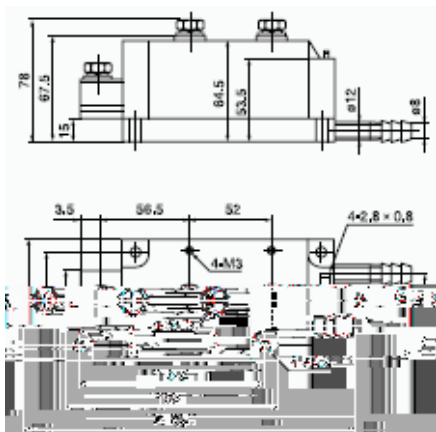

Fig.10 门极触发 曲线

外形图:



图

线路图:

MTC 250-1000A

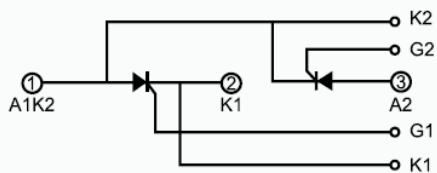

MTK

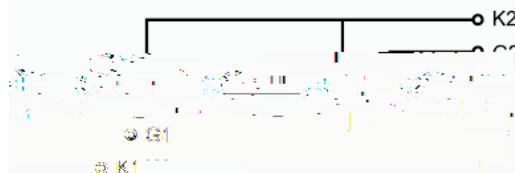

MTA

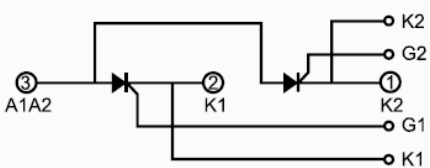

MTX

