

特点

典型应用

种整 源
 工业加热 , 调光, 无触发点开关
 软起动, 静止无 补偿
 焊 , 变频器, 源, 池充放

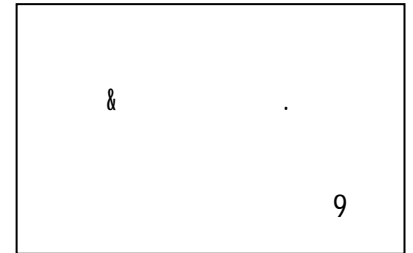

				最小	典型	最大	
!						"	
#							
\$&\$							&(
\$)&\$		$\equiv \quad * \quad \equiv$ (&(
*							
*		+					
*							
, -/	< (至壳)					"	&O
, ./,	< (壳至						&O
) 1	绝缘						
2	安装扭矩 (3.
	安装扭矩 (3.
4	储存 度						
O	质量						5
! (6)78	外形						

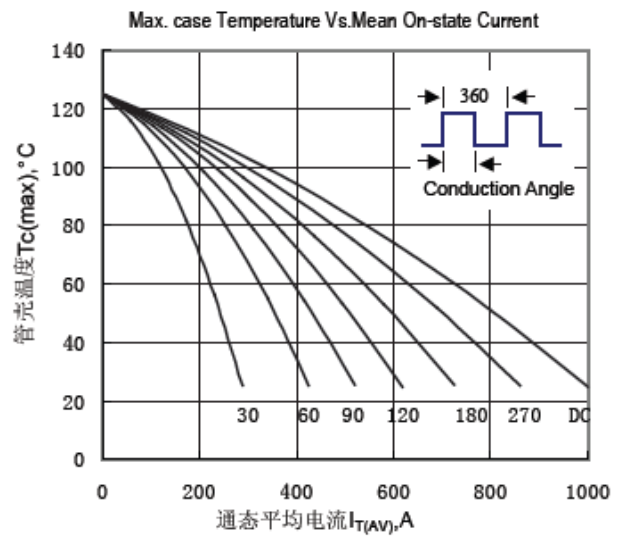
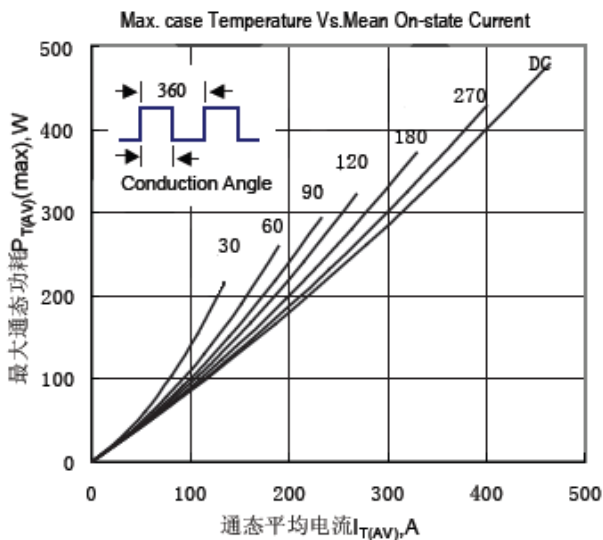
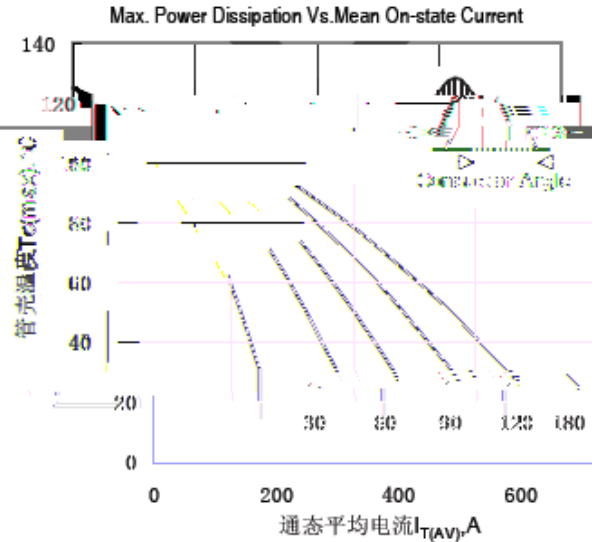
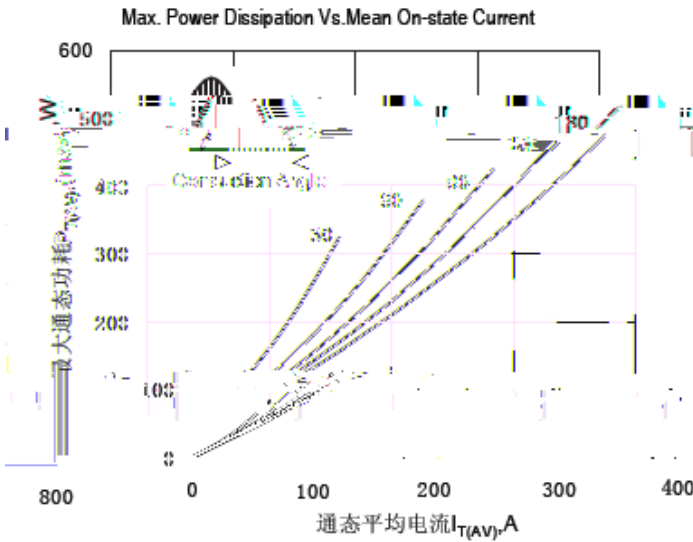
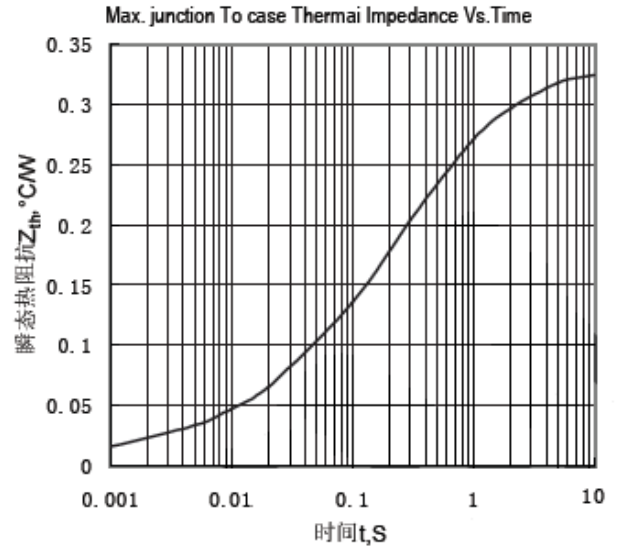
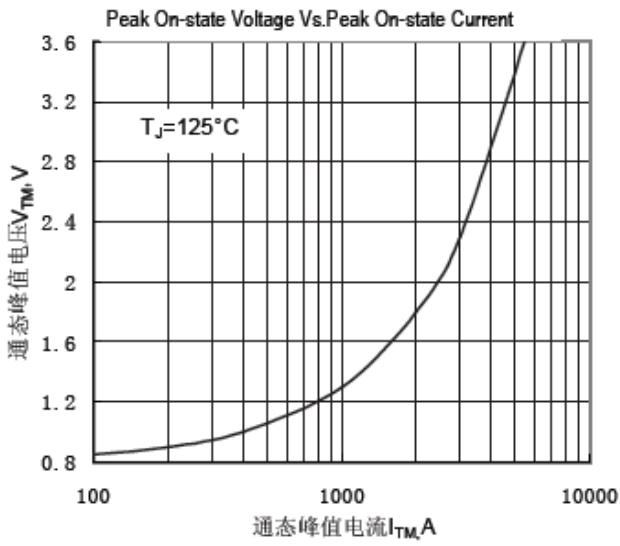

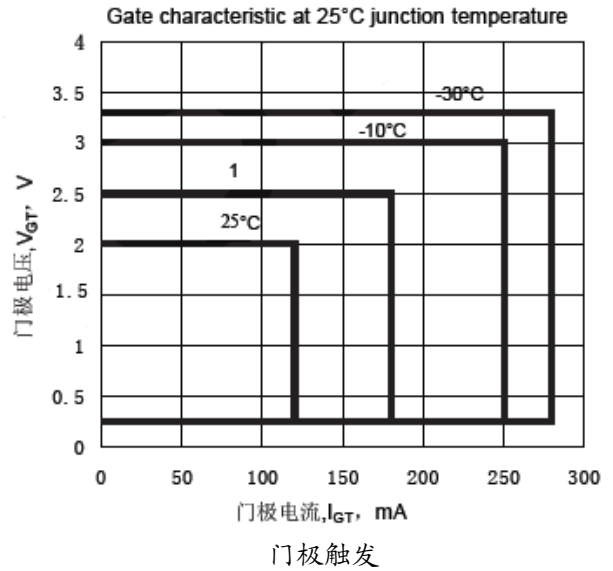
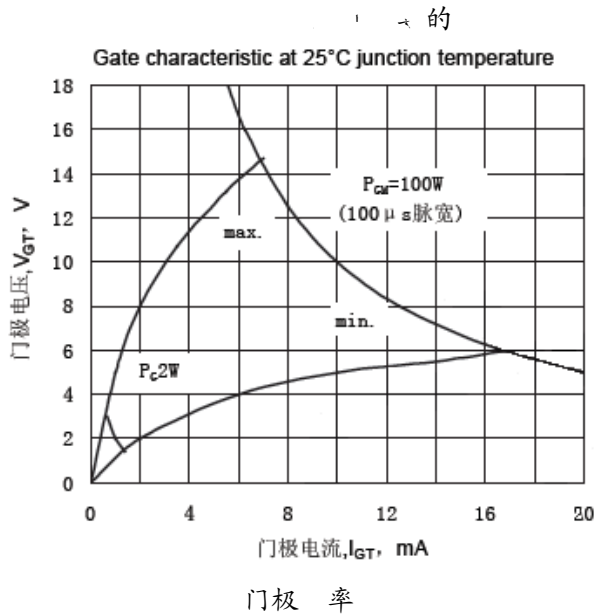
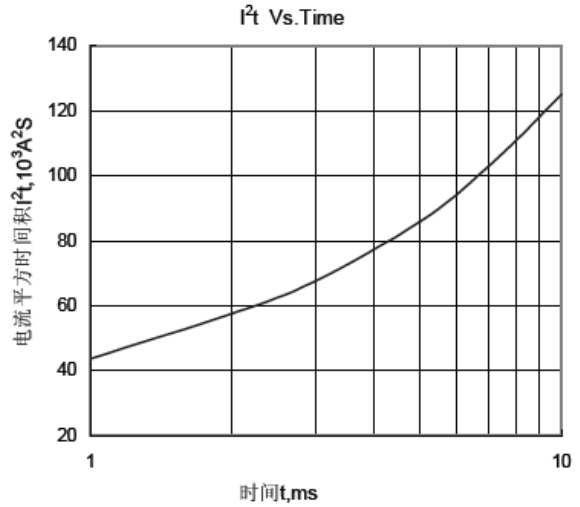
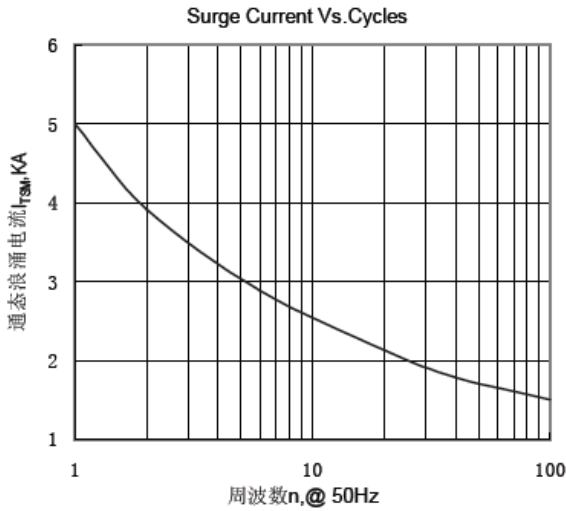

外形图:

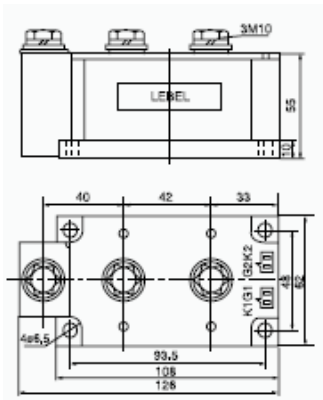

图

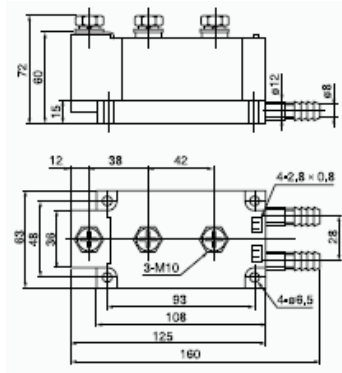

图

线路图：

MTC 250-1000A

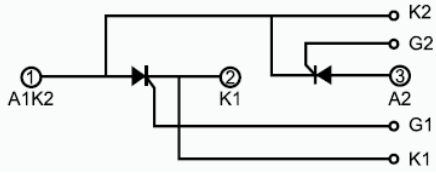

MTK



MTA

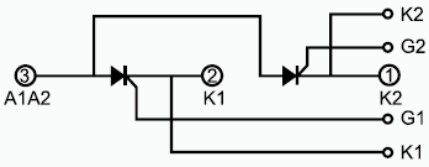

MTX

